



# Cordless Rivet Nut Setter



# N1B1

## Instruction Manual Original Instructions

ENGLISH

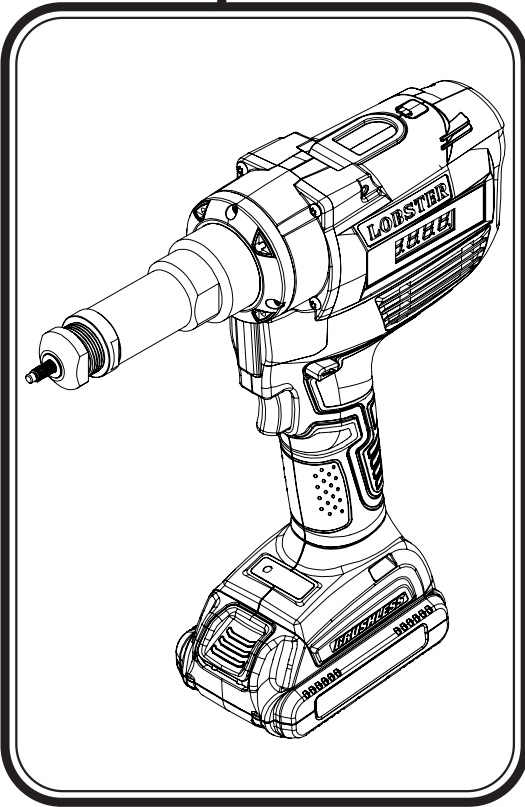

### Table of Contents

Introduction	2
Safety precautions	3
Names of components	10
Specifications	12
Preparation before use	13
Procedures for charging	14
How to adjust	16
Procedures for work	24
List of error indication	29
Troubleshooting	31
How to Order Parts	33
Parts Table	33

This machine is a dedicated tool for blind rivet nut for professional use.

Thank you for purchasing the LOBSTER brand cordless rivet nut setter.

- Before using this machine, thoroughly read this instruction manual to ensure proper operation.
- After reading this instruction manual, please save these instructions.
- When this machine becomes inoperable, refer to “Troubleshooting (page 31).”
- Note that the contents of this manual are subject to change without prior notice for improvement.
- Unauthorized publication, duplication, and translation of this instruction manual, in part or in whole, is prohibited.

**LOBTEX CO.,LTD.**

Call center Tel: +81-72-980-1111 Fax: +81-72-980-1166

12-8 Shijo-cho, Higashi-Osaka City, Osaka  
579-8053, Japan

Website <https://www.lobtex.co.jp/>  
No .NEN1B1SM2A50

# Introduction

Thank you for purchasing the LOBSTER brand Cordless Rivet Nut Setter (hereinafter abbreviated as this machine).

- \* This machine is a special tool for blind rivet nuts that is used to caulk and fasten shrimp-marked blind rivet nuts. We do not design, manufacture, or sell products intended for other uses.
- \* This instruction manual (hereinafter abbreviated as this manual) describes the correct operating methods, maintenance and inspection methods, and product information to use this machine safely and efficiently.
- \* Please use a rivet nut whose specifications and strength have been carefully designed by the customer.

## 1 Important notice

- \* Please read this manual carefully before handling this machine. Also, please follow the instructions in this manual when handling this machine and replacing accessories and parts.
- \* If you have any questions or concerns regarding the contents of this manual, please contact the store where you purchased the product or our call center.
- \* It is not possible to predict all the dangers that may exist with this machine and to describe them in this manual. When handling this machine, please pay sufficient attention not only to the information contained in this manual but also to safety measures.
- \* This book was written in Japanese as the original language. It is your responsibility to fully understand the contents of this document.
- \* The copyright of this book is owned by "Lobtex Co., Ltd." Unauthorized publication, copying, reproduction, or translation of the contents of this document into another language is prohibited.

## 2 About disclaimer

- \* We do not guarantee the rivet nut itself, including compensation for direct or indirect injuries or lost profits caused by misuse, abuse, or unauthorized modification of this machine, or the strength of the rivet nut.
- \* Our company shall not be responsible for any damage or failure caused by modification without our written approval.
- \* Our company assumes no responsibility for any damage or failure caused by the use of parts other than recommended parts.

Instruction manual revision history	
Product Name:	Cordless Rivet Nut Setter
Model	: N1B1
First edition publication date:	October 2024

# Safety precautions





◆ Before use, please read all of these “Safety precautions” carefully and fully understand them so that you can use the product correctly and safely.



◆ Be sure to wear safety goggles while using this machine. Failure to do so may result in an accident or injury (loss of eyesight, etc.) due to parts flying out.



◆ Always wear hearing protection while using this machine. When working with loud noises, wear earplugs or other hearing protection, as hearing may be adversely affected.

◆ The precautions shown here are divided into  **WARNING** and  **CAUTION**, and the meaning of each is as follows.



## WARNING

: Caution regarding contents that may cause death or serious injury to the user if handled incorrectly.



## CAUTION

: Caution regarding contents that may result in injury to the user or property damage if handled incorrectly.

Note that even the items listed under “!Caution” may lead to serious consequences. All of them contain important safety information, so be sure to follow them.

◆ After reading this manual, please be sure to keep it in a place where the user can refer to it at any time.



# WARNING



Compulsory

- 1. During charging, if charging is not completed even after a predetermined charging time, charging is stopped.**
  - Please contact the store where you purchased the product or our company. Continuing to charge the battery may cause an accident or injury.
- 2. If you notice a strange odor, heat generation, discoloration, deformation, or any other abnormality in the battery pack, immediately stop using it and remove it from the device or charger.**
  - Please contact the store where you purchased the product or our company. Continued use may cause an accident or injury.
- 3. Use with a power supply whose rating is indicated.**
  - Do not use in transformers such as DC power supplies, engine generators, transformers, and step-up devices. This may cause abnormal heat generation or fire.
- 4. Charge the battery pack in a well-ventilated place.**
  - Do not cover the battery pack or charger with cloth, etc. while charging. Doing so may cause heat generation, smoke, or fire.
- 5. If any abnormality such as smoke or strange odor occurs while using the charger, immediately stop using it and unplug the power plug from the outlet.**
  - Please contact the store where you purchased the product or our company. Continued use may cause an accident or injury.

# WARNING

- 6. If the battery liquid leaks out or abnormal odor is produced, immediately stop using the machine and keep the battery away from fire.**
  - Consult the store where you purchased this machine or us. Use of the battery in this condition may cause an accident or injury.
- 7. Carefully handle the battery pack and charger.**
  - Do not drop the battery pack and charger, and do not give a strong shock to them. If the outer case is broken, do not use the battery pack or charger. Failure to follow this instruction may cause an electric shock, smoke, fire, bursting, or other accident.
  - Do not disassemble or modify the battery pack and charger. Failure to follow this instruction may cause an electric shock, smoke, fire, bursting, or other accident.
  - Failure to follow this instruction may cause an accident or injury.
- 8. If the battery liquid has leaked out, do not touch it with bare hands, but take the following actions.**
  - If the battery liquid gets into your eye, you could become visually impaired in one eye. In this case, do not rub your eye, but wash it immediately with clean water and then consult a doctor.
  - If the battery liquid gets on your body or cloth, skin inflammation or injury may be caused. Sufficiently wash the liquid away with clean water and then consult a doctor.
  - Stop using a battery pack from which the battery liquid has leaked out, and do not put it close to fire. Immediately consult the store where you purchased this machine.
- 9. Positively insert the power plug all the way.**
  - If insertion is insufficient, an electric shock or heat generation may cause fire. Do not use a damaged plug and a loose receptacle.
- 10. If an abnormality, such as malfunctioning, heat generation, smoke, or abnormal sound is observed during use, immediately take out the battery pack and stop using this machine.**
  - Consult the store where you purchased this machine or us.  
Use of the battery in this condition may cause an accident or injury.
- 11. Use dedicated genuine parts only.**
  - Do not use parts other than the genuine parts that are listed in this document and our catalogues.  
Failure to follow this instruction may cause a serious accident or injury.
- 12. In replacement of a part or accessory, follow the specified procedures.**
  - If the specified procedures are not followed, a failure, an accident, or injury may occur.
- 13. When you do not use this machine or a risk is anticipated, turn off the switch on this machine and take out the battery pack from the machine body.**
  - Failure to follow this instruction may lead to an accident or injury when an unexpected action is made.
- 14. When conducting maintenance, inspection and part replacement, be sure to take out the battery pack.**
  - Failure to follow this instruction may lead to an accident or injury when an unexpected action is made.
- 15. If two or more battery packs are used in succession, stop this machine for about 15 minutes.**
  - Failure to follow this instruction may cause the temperature of the machine body to excessively rise, possibly leading to burns.



Compulsory

# WARNING



- 16. Do not immerse the battery pack in conductive liquid such as water. Do not let conductive liquid such as water enter the battery pack.**
  - If conductive liquid such as water enters the battery pack, short-circuiting occurs, possibly leading to heat generation, fire, or bursting.
- 17. Do not dispose of a used battery pack as household waste.**
  - Failure to follow this instruction may cause a disposed battery pack to be crushed inside a garbage truck and short-circuited, possibly leading to an accident such as fire.
- 18. Do not use this machine at a location where strong static electricity is generated.**
  - Failure to follow this instruction may cause an abnormal action, a liquid leakage, an electric shock, heat generation, smoke, fire, bursting, or other accident.
- 19. Do not use the battery with its polarities (+, -) reversed.**
  - Failure to follow this instruction may cause battery liquid leakage, electric shock, heat generation, smoke, fire, bursting, or other accident.
- 20. Do not directly connect the battery pack to the receptacle or a cigar lighter of an automobile.**
  - Failure to follow this instruction may cause battery liquid leakage, electric shock, heat generation, smoke, fire, bursting, or other accident.
- 21. Do not heat or highly pressurize the battery pack by putting it in a microwave oven or high-pressure vessel.**
  - Failure to follow this instruction may cause battery liquid leakage, electric shock, heat generation, smoke, fire, bursting, or other accident.
- 22. Do not use the battery pack for other usages than use on the designated machine.**
  - Failure to follow this instruction may cause battery liquid leakage, electric shock, heat generation, smoke, fire, bursting, or other accident.
- 23. When taking out a battery pack, do not put a metal object such as clip, coin, key, screw, or nail close to the battery pack.**
  - Failure to follow this instruction may cause the battery pack to shortcircuit, possibly leading to an electric shock, smoke, fire, bursting, or other accident.
- 24. Do not short circuit the terminals of a battery pack.**
  - Carrying or storing a battery pack with a metal object such as a pin may cause short-circuiting, possibly leading to smoke, fire, bursting, or other accident.
- 25. Do not put the battery pack in fire.**
  - Failure to follow this instruction may cause the production of harmful substances, smoke, fire, bursting, and other accident.
- 26. Do not use a charger that has a broken power plug or cable, has been dropped, or has been damaged.**
  - Failure to follow this instruction may cause an electric shock, heat generation, smoke, fire, or other accident.
- 27. Do not use or charge this machine at a location with flammable liquid or gas.**
  - Failure to follow this instruction may cause smoke, fire, explosion, or other accident.
- 28. Do not touch the power plug with a wet hand.**
  - Failure to follow this instruction may cause an electric shock.



# General Power Tool Safety Warnings

## **WARNING: Read all safety warnings and all instructions.**

Failure to follow the warnings and instructions may result in electric shock, fire and/or serious injury.

### **SAVE ALL WARNINGS AND INSTRUCTIONS FOR FUTURE REFERENCE**

The term “power tool” in the warnings refers to your mains-operated (corded) power tool or battery-operated (cordless) power tool.

## **1. Work area safety**

### **a. Keep work area clean and well lit.**

Cluttered or dark areas invite accidents.

### **b. Do not operate power tools in explosive atmospheres, such as in the presence of flammable liquids, gases or dust.**

Power tools create sparks which may ignite the dust or fumes.

### **c. Keep children and bystanders away while operating a power tool.**

Distractions can cause you to lose control.

## **2. Electrical safety**

### **a. Power tool plugs must match the outlet. Never modify the plug in any way.**

Do not use any adapter plugs with earthed (grounded) power tools. Unmodified plugs and matching outlets will reduce risk of electric shock.

### **b. Avoid body contact with earthed or grounded surfaces, such as pipes, radiators, ranges and refrigerators.**

There is an increased risk of electric shock if your body is earthed or grounded.

### **c. Do not expose power tools to rain or wet conditions.**

Water entering a power tool will increase the risk of electric shock.

### **d. Do not abuse the cord. Never use the cord for carrying, pulling or unplugging the power tool. Keep cord away from heat, oil, sharp edges or moving parts.**

Damaged or entangled cords increase the risk of electric shock.

### **e. When operating a power tool outdoors, use an extension cord suitable for outdoor use.**

Use of a cord suitable for outdoor use reduces the risk of electric shock.

### **f. If operating a power tool in a damp location is unavoidable, use a residual current device (RCD) protected supply.**

Use of an RCD reduces the risk of electric shock.

## **3. Personal safety**

### **a. Stay alert, watch what you are doing and use common sense when operating a power tool. Do not use a power tool while you are tired or under the influence of drugs, alcohol or medication.**

A moment of inattention while operating power tools may result in serious personal injury.

### **b. Use personal protective equipment. Always wear eye protection.**

Protective equipment such as dust mask, non-skid safety shoes, hard hat, or hearing protection used for appropriate conditions will reduce personal injuries.

### **c. Prevent unintentional starting. Ensure the switch is in the off-position before connecting to power source and/or battery pack, picking up or carrying the tool.**

Carrying power tools with your finger on the switch or energising power tools that have the switch on invites accidents.



## General Power Tool Safety Warnings

**d. Remove any adjusting key or wrench before turning the power tool on.**

A wrench or a key left attached to a rotating part of the power tool may result in personal injury.

**e. Do not overreach. Keep proper footing and balance at all times.**

This enables better control of the power tool in unexpected situations.

**f. Dress properly. Do not wear loose clothing or jewellery. Keep your hair, clothing and gloves away from moving parts.**

Loose clothes, jewellery or long hair can be caught in moving parts.

**g. If devices are provided for the connection of dust extraction and collection facilities, ensure these are connected and properly used.**

Use of dust collection can reduce dust-related hazards.

**h. Do not let familiarity gained from frequent use of tools allow you to become complacent and ignore tool safety principles.**

A careless action can cause severe injury within a fraction of a second.

### 4. Power tool use and care

**a. Do not force the power tool. Use the correct power tool for your application.**

The correct power tool will do the job better and safer at the rate for which it was designed.

**b. Do not use the power tool if the switch does not turn it on and off.**

Any power tool that cannot be controlled with the switch is dangerous and must be repaired.

**c. Disconnect the plug from the power source and/or the battery pack from the power tool before making any adjustments, changing accessories, or storing power tools.**

Such preventive safety measures reduce the risk of starting the power tool accidentally.

**d. Store idle power tools out of the reach of children and do not allow persons unfamiliar with the power tool or these instructions to operate the power tool.**

Power tools are dangerous in the hands of untrained users.

**e. Maintain power tools. Check for misalignment or binding of moving parts, breakage of parts and any other condition that may affect the power tool's operation. If damaged, have the power tool repaired before use.**

Many accidents are caused by poorly maintained power tools.

**f. Keep cutting tools sharp and clean.**

Properly maintained cutting tools with sharp cutting edges are less likely to bind and are easier to control.

**g. Use the power tool, accessories and tool bits etc. in accordance with these instructions, taking into account the working conditions and the work to be performed.**

Use of the power tool for operations different from those intended could result in a hazardous situation.

**h. Keep handles and grasping surfaces dry, clean and free from oil and grease.**

Slippery handles and grasping surfaces do not allow for safe handling and control of the tool in unexpected situations.



## General Power Tool Safety Warnings

### 5. Battery tool use and care

**a. Recharge only with the charger specified by the manufacturer.**

A charger that is suitable for one type of battery pack may create a risk of fire when used with another battery pack.

**b. Use power tools only with specifically designated battery packs.**

Use of any other battery packs may create a risk of injury and fire.

**c. When battery pack is not in use, keep it away from other metal objects, like paper clips, coins, keys, nails, screws or other small metal objects, that can make a connection from one terminal to another.**

Shorting the battery terminals together may cause burns or a fire.

**d. Under abusive conditions, liquid may be ejected from the battery; avoid contact. If contact accidentally occurs, flush with water. If liquid contacts eyes, additionally seek medical help.**

Liquid ejected from the battery may cause irritation or burns.

**e. Do not use a battery pack or tool that is damaged or modified.**

Damaged or modified batteries may exhibit unpredictable behaviour resulting in fire, explosion or risk of injury.

**f. Do not expose a battery pack or tool to fire or excessive temperature.**

Exposure to fire or temperature above 130 °C may cause explosion.

**g. Follow all charging instructions and do not charge the battery pack or tool outside the temperature range specified in the instructions.**

Charging improperly or at temperatures outside the specified range may damage the battery and increase the risk of fire.

### 6. Service

**a. Have your power tool serviced by a qualified repair person using only identical replacement parts.**

This will ensure that the safety of the power tool is maintained.

**b. Never service damaged battery packs.**

Service of battery packs should only be performed by the manufacturer or authorized service providers.



# CAUTION



Compulsory

1. **Carefully take care of the charger.**
  - Periodically inspect the power cable of the charger, and if it is damaged, request the store where you purchased this machine or us for repair. Failure to follow this instruction may cause an electric shock or short circuit.
  - If you use an extension cord, periodically inspect it, and if it is damaged, replace it with a new one. Failure to follow this instruction may cause an electric shock or short circuit, possibly leading to fire.
2. **If you do not use the charger, disconnect the power plug of the charger from the receptacle.**
  - This prevents accidents such as electric shock and fire.
3. **Wipe dust and dirt accumulated on the power plug and receptacle with a dry cloth.**
  - This prevents accidents such as electric shock and fire.
4. **When charging is not being carried out, remove the battery pack from the charger.**
  - This prevents accidents such as electric shock and fire.
5. **Check whether there is any damaged part.**
  - Thoroughly check this machine before use for damage, and check whether this machine normally operates and performs its specific functions.
  - Check the movable part for installation condition, parts for damage, and all the other components that affect operation for abnormality.
  - If this machine cannot be started or stopped through the operation of the trigger switch, stop using this machine.  
Failure to follow this instruction may lead to an accident or injury when an abnormal action is made.
6. **When you do not use this machine, adequately store it.**
  - Store this machine at a dry location that is at a height beyond the reach of children or can be locked with a key. Failure to follow this instruction may cause an accident or injury.
7. **While lightning is occurring, do not charge the battery, and disconnect the power plug from the receptacle.**
  - Failure to follow this instruction may lead to a failure, accident, or injury due to lightning strike.
8. **At the time of the first use of this machine after its purchase, if a large amount of rust, damage, abnormal odor, abnormal heat generation, or other abnormality is observed, stop using the machine.**
  - Consult the store where you purchased this machine or us.  
Use of the battery in this condition may cause an accident or injury.



Prohibition

9. **When you work at height, confirm that no one is beneath you.**
  - Failure to follow this instruction may lead to an accident due to the falling of material, this machine, or mandrel of a cut rivet.
10. **When the machine body has become hot, suspend work, and after the machine body has cooled down, resume the work.**
  - Failure to follow this instruction may cause you to get burned.
11. **Do not store this machine at a location where the ambient temperature could rise to 50°C or higher (metallic box, automobile in summer, etc.).**
  - Such an environment may cause deterioration of the machine as well as an electric shock, heat generation, smoke, fire, bursting, or other accident.
12. **Do not operate this machine with its frame head dismantled.**
  - Failure to follow this instruction may cause your finger to be pinched, possibly leading to injury.
13. **Do not scatter the mandrels of cut rivets.**
  - If mandrels are scattered, an accident or injury may occur.
14. **Do not allow an LED light to directly irradiate your eyes.**
  - If an LED light continuously irradiates your eyes, your eyes may be damaged.

# Names of components

## ● Machine body

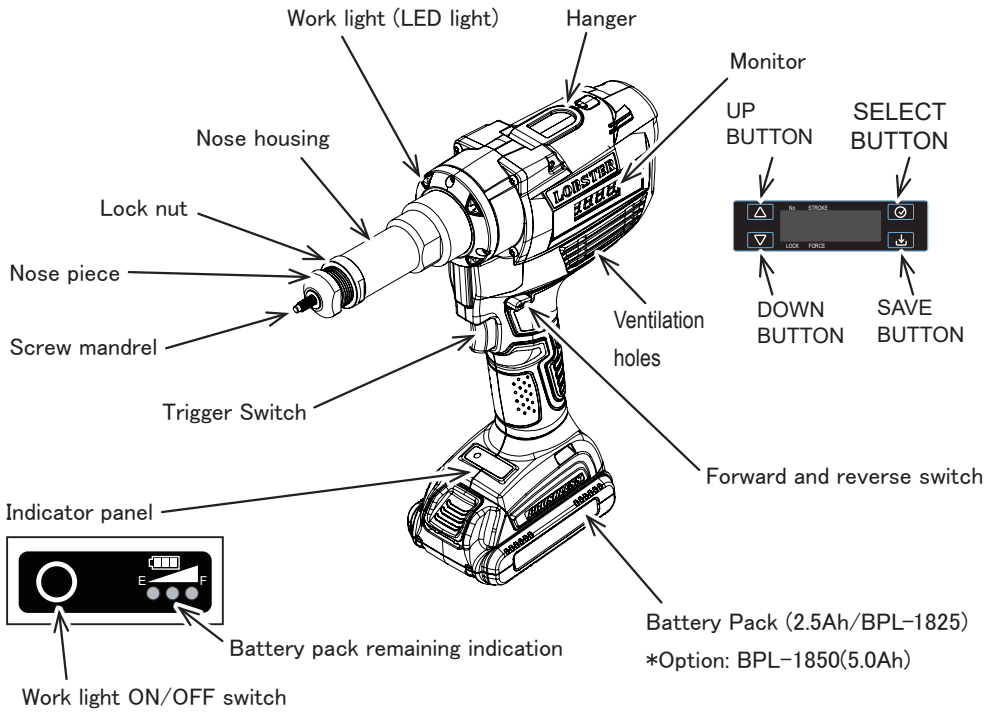

## ● Replacement parts are used to replace fastening blind rivet nuts

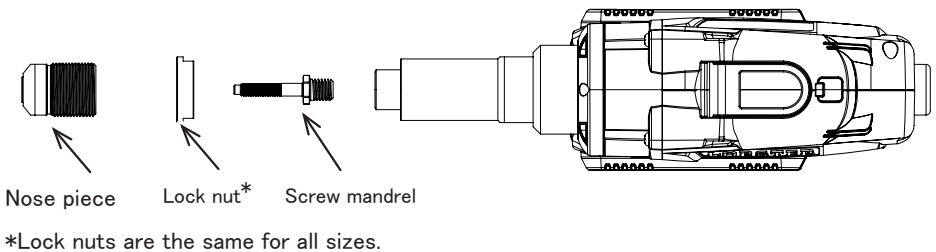

## ● Battery pack

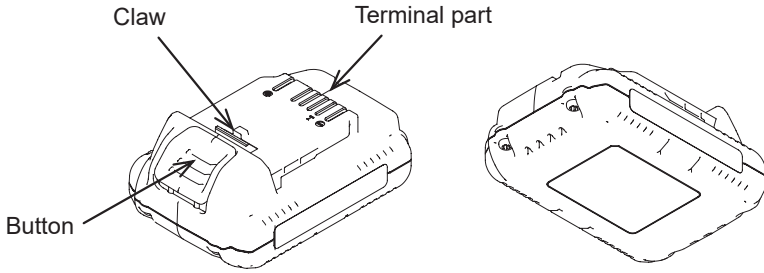

## ● Charger

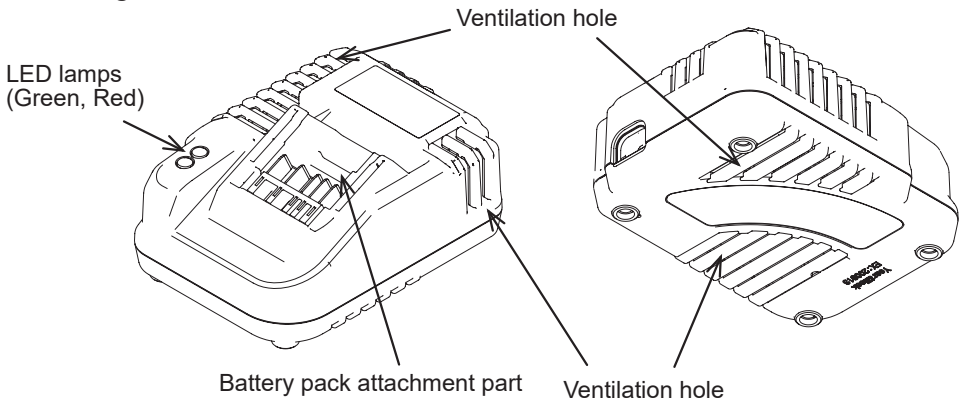

## ● Power cable

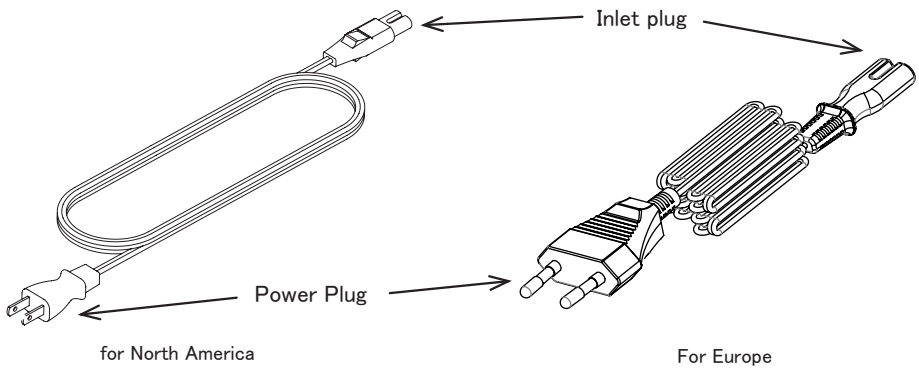

# Specification

Battery capacity		Standard capacity	Large capacity (optional)	
Machine body	Model number	N1B1		
	Weight	2.6kg	2.9kg	
	Power source	18 V d.c.		
	Dimensions	L292 × W76 × H285 mm	L292 × W76 × H304 mm	
	Tool stroke	0.1mm ~ 10mm (0.1mm steps)		
	Nominal output	19.6 kN		
	Applicable rivet diameters	M3、M4、M5、M6、M8、M10 (Blind rivet nut)		
	Operating environment	Ambient temperature	0°C to 40 °C	
	Noise emission value	L <sub>PA</sub> = 79.7 dB(A), L <sub>WA</sub> = 87.7 dB(A), K <sub>PA</sub> /K <sub>WA</sub> = 3dB(A)		
	Vibration emission value	2.5 m/s <sup>2</sup> or less, Measurement uncertainty K= 1.5m/s <sup>2</sup>		
Battery pack	Model number	BPL-1825	BPL-1850	
	Battery	Li-ion rechargeable battery		
	Rating voltage	18 V d.c.		
	Rating capacity	2.5 Ah	5.0 Ah	
	Weight	400 g	690 g	
	Dimensions	L116 × W76 × H49 mm	L116 × W76 × H68 mm	
Charger	Model number	BC037T		
	Power source	For Europe : 100 to 240V ~ 50/60Hz 60W For North America : 120V ~ 60Hz 60W		
	Rating charging voltage	20.75V d.c.		
	Rating charging current	2.3A		
	Charging time	65 minutes	130 minutes	
	Dimensions	L145 × W109 × H70 mm		
	Weight	395 g		
	Operating environment	Ambient temperature	0°C to 40 °C	

- \* The specifications and design of the product are subject to change without prior notice.
- \* The dimensions, weight, and other amounts are standard values. They may slightly vary depending on the actual product.
- \* The location of rating name plate (attachment location of CAUTION/WARNING plates) is the side face at the top part of the machine body.
- \* The serial number is indicated on the bottom of the unit by three-digit alphanumeric characters and five-digit numbers. (For the location and reading of the serial number, see page 29 of the instruction manual.)
- \* That the declared vibration total value has been measured in accordance with a standard test method and may be used for comparing one tool with another.
- \* That the declared vibration total value may also be used in a preliminary assessment of exposure.
- \* that the vibration emission during actual use of the power tool can differ from the declared total value depending on the ways in which the tool is used; and
- \* of the need to identify safety measures to protect the operator that are based on an estimation of exposure in the actual conditions of use (taking account of all parts of the operating cycle such as the times when the tool is switched off and when it is running idle in addition to the trigger time).

# Preparation before Use

- 1** Charge the battery pack before using this machine. (Refer to page 14.)
- 2** Replace the parts (nose piece, screw mandrel) in accordance with the size of the blind nut rivet in use. (Refer to page 16.)

Blind rivet nut size (screw diameter)	Nose piece	Screw mandrel
M3	Nose piece M3	Screw mandrel M3
M4	Nose piece M4	Screw mandrel M4
M5	Nose piece M5	Screw mandrel M5
M6	Nose piece M6	Screw mandrel M6
M8	Nose piece M8	Screw mandrel M8
M10	Nose piece M10	Screw mandrel M10

Standard blind nut rivets of each size can be used simply by replacing the nose piece and screw mandrel. A nosepiece and screw mandrel for M6 size, a nosepiece and screw mandrel are attached at the time of purchase.

## ⚠ CAUTION

Do not work with the wrong combination of parts even when a blind rivet nut can be inserted. Failure to follow this instruction may cause a failure or accident.

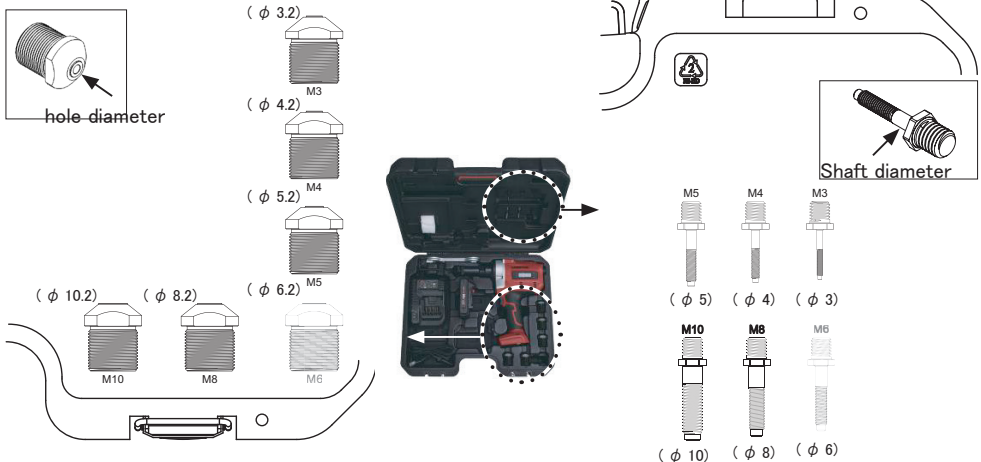

### < How to check nose piece and screw chuck >

The nose piece and screw chuck do not have thread size markings. Measure the hole diameter for a nose piece and the shaft diameter for a screw chuck to confirm.

# Procedures for charging

For charging of the battery, be sure to use the dedicated charger.

- 1** Connect the power cable to the charger ( ① ) and insert the power plug into a power outlet ( ② ). When power is applied, the green LED lamp will flash slowly.

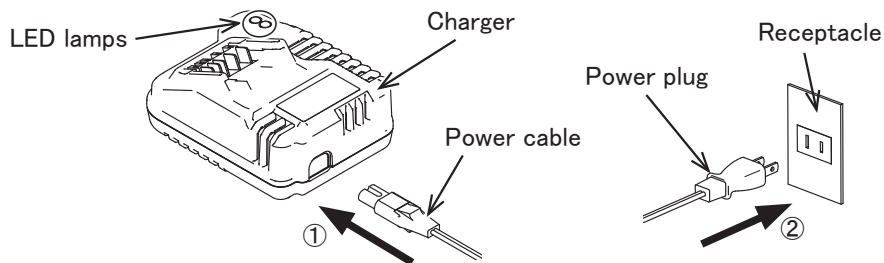

## ⚠ CAUTION

This charger can be used with 100 to 240V ~ 50/60Hz. (Europe)

This charger can be used with 120V ~ 60Hz. (North America)

Do not use the charger by connecting it to a DC power source or an engine power generator.

- 2** Positively insert the battery pack all the way to the back of the charger. When the battery pack is inserted to the back, the lighting condition of the LED lamps changes. The contents of indications of the LED lamps are as shown in the following table.

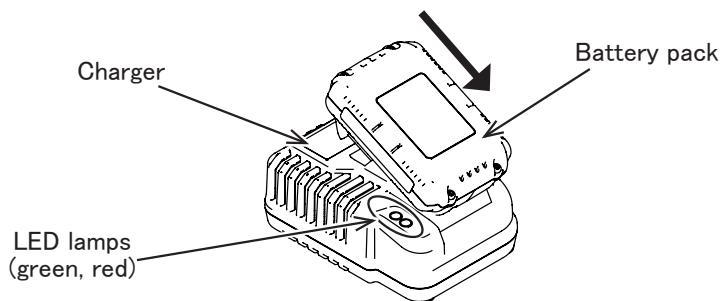

LED lamp lighting condition		Contents of indication
Red	Green	
–	Blinking (low speed)	Standby for charging (charger is energized)
Lit	–	Charging in progress
–	Blinking (high speed)	Completion of practical charging (completion of 80% charging, full charging in progress)
–	Lit	Full charging completed (charging completed)
Blinking (low speed)	–	Charging is suspended due to a temperature out of appropriate temperature range
Lit	Lit	Charging disabled (abnormal state)

### ⚠ CAUTION

When the temperature of the battery pack is high or low, it will not be charged to protect the battery pack. When the temperature of the battery pack enters the appropriate range, charging starts.

Charge the battery in the ambient temperature range of 0 to 40°C .

- 3** When the charging is completed, remove the battery pack from the charger, and disconnect the power plug from the receptacle.

## Number of fasteners

This is the number of units that can be tightened continuously when the battery pack is fully charged.

[pcs.]

Blind rivet nut body diameter	Battery pack 2.5 Ah (typical)	Battery pack 5.0Ah (Optional)
M3	1,300	2,600
M4	1,300	2,600
M5	1,200	2,400
M6	1,000	2,000
M8	700	1,400
M10	600	1,200

The number of fasteners is approximate.

It varies depending on the rivet used, the base material specification, and the condition of the battery pack.

# ● How to adjust

## How to replace the screw mandrel and nose piece and how to adjust the protrusion of the screw mandrel

**1** Be sure to remove the battery pack.

**⚠ CAUTION**

If you replace parts or adjust the screw mandrel protrusion without removing the battery pack, the unit may operate unintendedly and you may be injured.

**2** Loosen the nosepiece lock nut with the included wrench (opening 27 mm) and remove the nosepiece and nosepiece lock nut from the nose housing.

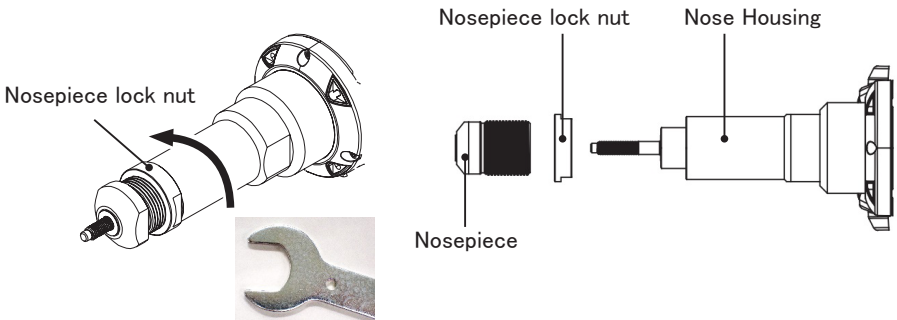

**3** Pull the slide unit backward until the flange of the mandrel is visible (①), then turn the mandrel by hand to remove it (②).

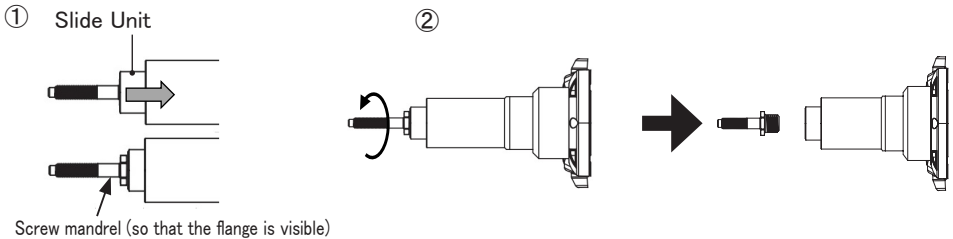

**⚠ CAUTION**

Please be careful as scratches or chips on the mandrel may injure your fingers.



- 4** Replace the nosepiece and screw mandrel with the size you will be using. The nosepiece lock nut is the same for all sizes.

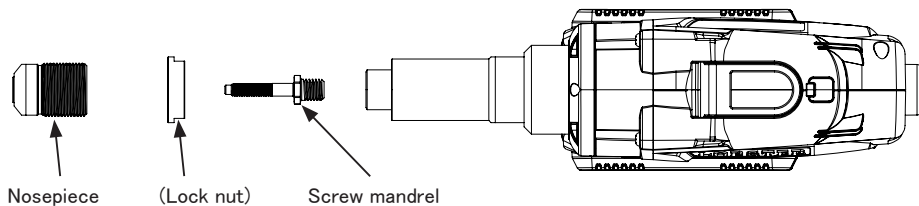

- 5** With the slide unit pulled backwards (①), screw in the screw mandrel until it touches the flange (②). Then, release the slide unit and slowly turn the screw mandrel to the left (③), then return it to the original position until the flange clicks into place (④).

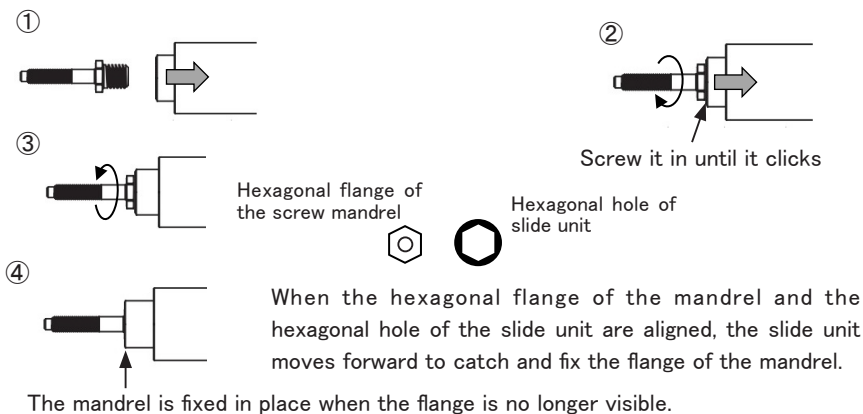

- 6** Gently screw the lock nut onto the nosepiece by hand.

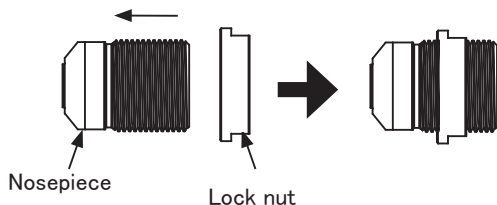

\*This will be fixed after adjusting the mandrel protrusion, so it is currently only temporarily fastened.

7

Lightly screw the nosepiece into the nose housing.

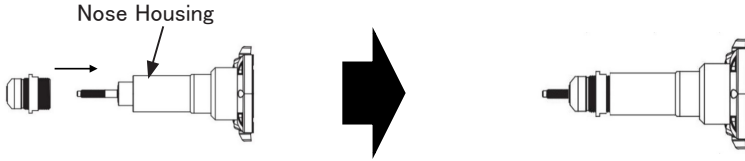

\* The screw mandrel protrusion will be adjusted and then fixed, so this is just a temporary fix for now.

8

Adjust the position of the nosepiece so that when you insert the nut you are using (press the nut against the nosepiece), the tip of the mandrel protrudes by about one thread.

Blind rivet nut to be used

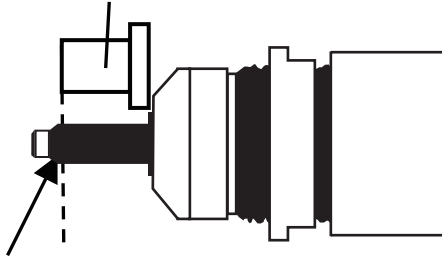

Adjust so that a creat comes out.

9

While holding the nosepiece so that it does not move, use the included wrench (opening 27 mm) to firmly tighten the lock nut onto the nose housing.

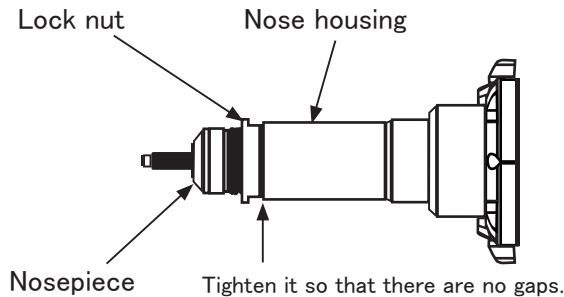

### ⚠ CAUTION

If the screw mandrel protrudes too far, the rivet nut may not be fully inserted. Conversely, if it is too small, the threads of the rivet nut may be damaged when the rivet nut is tightened.

# How to input and adjust stroke and output

The stroke and output of this machine must be adjusted according to the thickness of the nut and base material being used. Follow the procedure below to input the crimping stroke and output, and adjust so that the crimping allowance of the nut is appropriate. Input is done using the buttons next to the LED display screen.

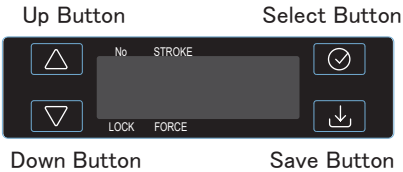

**⚠ CAUTION**

If the power goes out while you are inputting data, all data you have inputted up to that point will be discarded, and when you turn the power back on, you will return to the initial screen.

- 1 When you pull the trigger switch, the power turns on and the display lights up on the monitor.
- 2 Press the Select button (⊙). (For more than 3 seconds but less than 5 seconds) The first two characters will be full light, the last two characters will be half light, and the bar for the second character will be in the middle position. This will take you to the memory number selection screen for saving the settings. Press the Up button (▲) or Down button (▼) to select the memory number to register. (This unit can save 10 settings, memory numbers 0 to 9.)



- 3 Press the Select button (⊙) to enter the stroke. (Less than 3 seconds) The first character will be half lit, the next 3 characters will be fully lit, and the bar for the second character will be the STROKE position above, and the screen for entering the stroke will appear. Press the Up button (▲) and Down button (▼) to enter the stroke (long press to fast forward). The stroke can be set in 0.1mm increments between 0.1 and 10mm.



**⚠ CAUTION**

If you continue to press the Select button (⊙) for more than 3 seconds, your input will be discarded and you will return to the initial screen.

Regarding the stroke value to enter, check the thickness of the base material and check the appropriate caulking from the caulking table attached to the rivet nut you are using.

(Example) When the crimping allowance table for the Shrimp Nut is shown on the right, if the thickness of the base material (crimping plate thickness) is 1.0 mm, the appropriate crimping allowance is 3.5 mm.

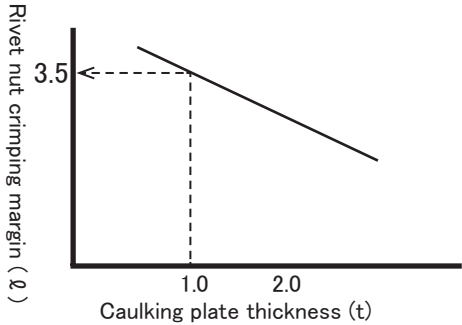

**⚠ CAUTION**

**Since each unit is different, it is necessary to make adjustments at the end.**

- 4** Press the Select button (✔) to proceed to the crimp output input. (Less than 3 seconds) The first character will be half lit, the next 3 characters will be fully lit, the bar for the second character will move to the FORCE position below, and the screen for inputting the output will appear. Press the Up button (▲) and Down button (▼) to input the output (long press to fast forward). The output can be set in increments of 1 between 01 and 99.



When using our rivet nuts, please check the output value to be entered from the output setting table for each of our rivet nuts on page 30.



(Example)  
If you are using our rivet nut NSK-6M, please set “60” in the output setting table on page 30.

\*If you are using a blind rivet nut from another manufacturer that is not listed in the output setting table, please enter “99” .

\* The crimping output setting is a function to prevent damage to the screw mandrel or breakage of the threads of our rivet nuts due to excessive crimping (such as double crimping), and is not a function to control the crimping condition by adjusting the output. If you do not need this function, set it to “99” .

**⚠ CAUTION**

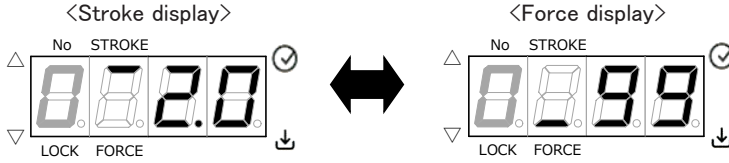

**The numbers are numbers that call up pre-set outputs and are not the actual output values. If you continue to press the Select button (✔) for more than 3 seconds, the input will be discarded and you will return to the initial screen.**

- 5** Save button (  ) Press (2 seconds or more) [Configuration complete]  
The settings are saved to the memory number selected in **2** . If you want to check the output again, click the Select button (  ) Please press.



### ⚠ CAUTION

If you press the Select button (  ) (less than 3 seconds) instead of the Save button (  ), you will be returned to the memory number selection screen.

If you press the Select button (  ) instead of the Save button (  ) for more than 3 seconds, discard the newly entered settings and return to the initial screen.

If you press the Select button instead of the Save button for more than 3 seconds, discard the newly entered settings and return to the initial screen.

- 6** Adjust the blind nut you are using by actually tightening it.

- ① Measure the total length of the blind rivet nut before biting.
- ② Measure the total length of the blind rivet nut after it has been chewed, and subtract the dimensions from the dimensions before caulking. Please calculate the actual caulking margin. Refer to <Work Instructions> when biting the blind rivet nut.



Caulking dimension (  $\ell$  ) =

Total length of nut before caulking - Total length of nut after caulking

- ③ Adjust the input value of the stroke so that the caulking margin is within  $\pm 0.3$  mm.  
(If the stroke cannot be adjusted, adjust the input value of the output.)

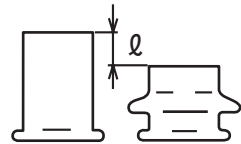

### ⚠ CAUTION

1. As there are individual differences depending on the machine, adjustments are necessary for each machine even when using the same rivet nut.
2. When raising the setting value, do so gradually. Raising it too much may damage the rivet nut threads or cause damage to the screw mandrel and other parts of the machine.
3. If the stroke is too little or the output is too weak, the rivet nut will not be sufficiently crimped and will spin freely.
4. If the stroke is too long and the output is too strong, the rivet nut will be over-crimped and the threads will break.

\*The rivet nut will break if both the stroke and output are large.

# Input button lock method

This machine can lock the input buttons to prevent settings from being changed accidentally.

Up button                      Select button



Down button                      Save button

**1** Pull the trigger switch to turn the power on.

**2** [Button Lock]

Pressing and holding the Select button (✓) for more than 5 seconds will lock the buttons. The dot after the first character will light up, then all characters will be half-lit. The display will remain fixed at the stroke setting.

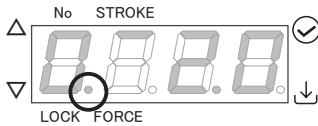

**2** [Button unlock]

With the buttons locked, press and hold the Select button (✓) for more than 5 seconds. The dot after the first character will turn off. All characters will be fully lit and the display will alternate between stroke → output → stroke, stopping at the stroke display.

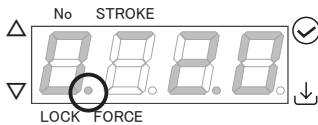

## ⚠ CAUTION

The buttons will also be unlocked if the machine is left unused for three minutes or if the battery pack is removed and the power is turned off.

# Counter display method

The machine is equipped with a counter, which can be displayed by following the steps below.

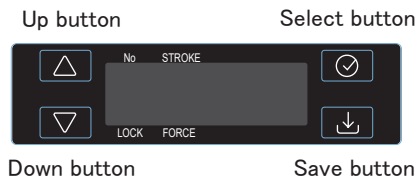

**⚠ CAUTION**

If the machine is left without operation for 3 minutes, or if the battery pack is removed and the power goes out, the counter display will return to the initial screen.  
\* The counter will not be reset.

**1** Pull the trigger switch to turn the power on.

**2** [Counter display]  
Press the Down button (▽) and Save button (⇩) simultaneously for more than one second to display a counter. All four characters will be numbers, and the total number of rivet nuts that have been fastened so far will be displayed. Each time a rivet nut is fastened, the counter will increase.

**⚠ CAUTION**

After the counter reaches 9999, it will return to 0000.



**3** [Cancellation of counter display]  
When the counter is displayed, press the Down button (▽) and Save button (⇩) simultaneously for more than one second to return to the initial screen.

**4** [Resetting the counter]  
When the counter is displayed, pressing and holding the Select button (✔) for more than 10 seconds will reset the counter to 0.



**5** [Counter display lock]  
If you press and hold the Select button (✔) for more than 5 seconds while the counter is displayed, the rightmost dot will light up and button operation will be locked while the counter is displayed.



**6** [Unlocking the counter display]  
When the counter display is locked, pressing and holding the Select button (✔) for more than 10 seconds will cause the rightmost dot to turn off and the buttons to be unlocked.



# ● Work procedure

- 1 Drill a suitable pilot hole in the base material that matches the rivet nut you will be using.
- 2 Install the battery pack and pull the trigger switch to turn it on.
- 3 Press the Up button (▲) and Down button (▼) to recall the previously registered memory number (0 to 9).

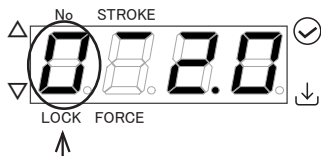

The leftmost number is the memory number, which ranges from 0 to 9.

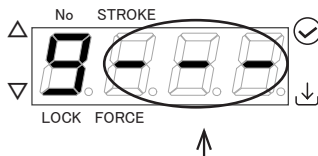

If no settings are registered to the memory number, “-” will be displayed.

When registering new settings, please refer to page 19 for stroke and output input and adjustment methods.

- 4 The flashing work light indicates that the machine is waiting to load rivet nuts. To turn the work light ON and OFF, press the work light ON/OFF button on the indicator panel.



Work light ON/OFF button

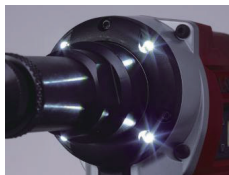

<When the work light is ON>  
 | Blinking: Waiting for rivet nuts to  
 | be imported  
 | Lighting: Rivet nuts imported  
 | successfully

- 5 Gently pinch the rivet nut and press it against the screw mandrel. The screw mandrel will rotate forward and the rivet nut will be taken in. (While the screw mandrel is rotating, continue to press the rivet nut. The screw mandrel will rotate a certain number of times and then stop.)

If the work light ON/OFF switch is set to ON, the work light will change from flashing to lit when the rivet nut is successfully imported. If the work light remains flashing and an import error message is displayed on the monitor, the rivet nut import has failed. Refer to “The rivet nut cannot be crimped even when the trigger switch is pulled” on page 26, reverse the screw mandrel to remove the rivet nut, then press it against the screw mandrel again to import the rivet nut again.



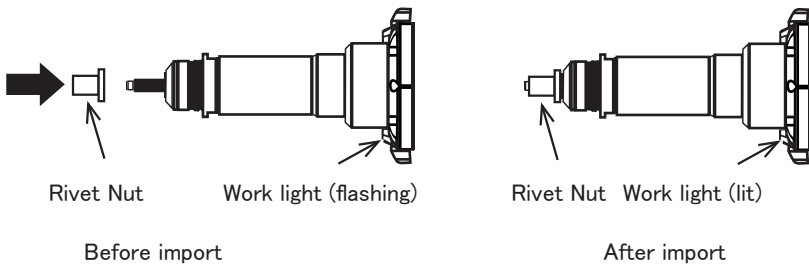

## ⚠ CAUTION

If the forward/reverse switch is in the reverse position, the screw mandrel will not rotate even if the rivet nut is pressed against the screw mandrel. Make sure that the forward/reverse switch is in the forward position before pressing the rivet nut against it.

- 6** Insert the rivet nut vertically into the pilot hole in the base material, press the flange against the base material, and pull the trigger switch. After the rivet nut has been crimped, the screw mandrel will reverse and come out of the rivet nut.

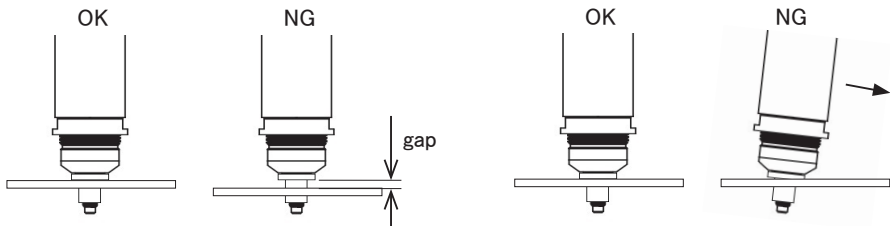

If you are using work lights they will change from solid to flashing.

## ⚠ CAUTION

If there is a gap between this machine and the base material, or if the machine is used at an angle to the base material, the rivet nut may get caught in the screw mandrel, preventing the screw mandrel from being removed or causing the screw mandrel to break.

# What to do in case of an abnormality

## <The rivet nut cannot be crimped even if the trigger switch is pulled>

If the rivet nut is not properly captured, an error will be displayed on the monitor and the rivet nut will not be crimped. (If a work light is being used, the work light will not light up.)

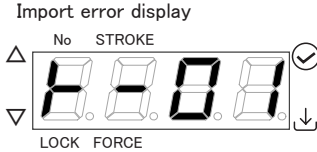

- 1 Turn the forward/reverse switch to reverse, and while lightly pinching the rivet nut, rotate the screw mandrel in the opposite direction to remove the rivet nut.

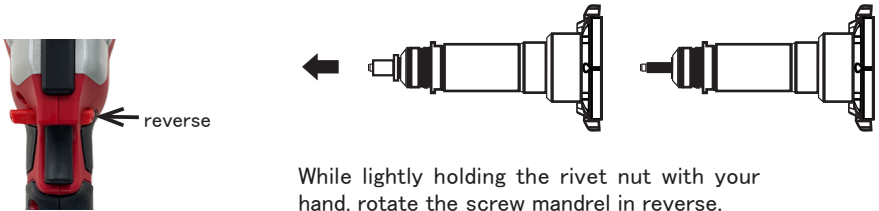

While lightly holding the rivet nut with your hand, rotate the screw mandrel in reverse.

### CAUTION

The capture error will not be cleared even if you remove the rivet nut by turning it by hand. Even if you remove the rivet nut by turning it by hand, please set the forward/reverse switch to reverse, pull the trigger switch, and clear the capture error.

- 2 When inserting the rivet nut, readjust so that the protrusion of the screw mandrel is about one thread at the tip. (See page 18.)

<The rivet nut is stuck in the screw mandrel and cannot be removed>

**1** Be sure to remove the battery pack.

**⚠ CAUTION**

The machine may move unexpectedly and cause injury.

**2** Insert the included hex wrench (4mm across flats) into the hex hole at the rear of the machine and turn it counterclockwise to forcefully turn the screw mandrel and remove the rivet nut. Then turn it clockwise about 3 times to return it to its original position.

1. Rotate counterclockwise until the rivet nut comes out

2. Once the rivet nut has come out, rotate it three times to the right



**⚠ CAUTION**

Be sure to remove the hexagonal wrench after work is completed.

\* If you continue to turn the hex wrench excessively after the rivet nut has been removed, the motor may start operating in response to the sensor, causing the hex wrench to start rotating. Be sure to remove the battery pack before working.

**3** Attach the battery pack and insert the next rivet nut.

**⚠ CAUTION**

If there is no error displayed on the monitor after performing this procedure, but the screw mandrel does not move even when the rivet nut is pressed against it, remove the battery pack again, insert the hex wrench into the hex hole, and turn it clockwise about 3 times before returning it to its original position.

## Cleaning and inspection of each part

### <Checking the charger>

After unplugging the power plug from the outlet, check that the power cable is not damaged and that there is no dirt on the terminals.

### <Cleaning>

Wipe the machine, battery pack, and charger with a soft cloth.

The use of organic solvents such as thinner or benzene may cause deformation, discoloration, or cracking.

### <Battery pack life>

Battery packs have a lifespan. If the number of crimps becomes extremely low even when the battery is properly charged, the battery pack has reached the end of its life. Please replace it with a new battery pack.

### WARNING

Do not use any battery packs other than those specified by our company or modified ones (including those with replaced batteries, etc.).

We are not responsible for any accidents or malfunctions that may occur if they are used in this way.

### <About recycling>

The battery pack used in this product is a recyclable lithium-ion battery.

To help recycle valuable resources and protect the environment, please take any battery packs you no longer need to the store where you purchased the product. (To prevent short circuits, be sure to attach insulating tape to the terminals of the battery pack.)

When disposing of tools, please dispose of them in accordance with national and local waste disposal laws, regulations, and ordinances.



## How to store products

After use, store in a dry place out of reach of children.







Also, if the product will not be used for a long period of time, remove the battery pack from the machine body.

If the product will not be used for a long period of time (6 months or more), store it in a place below 35°C.

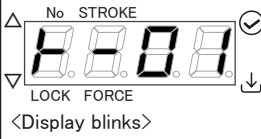
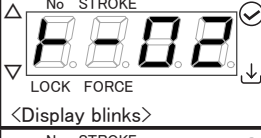
To prevent the battery pack from over-discharging, regularly charge it to its practical capacity.

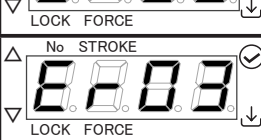
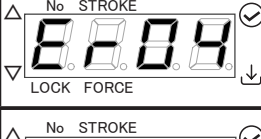
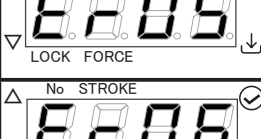
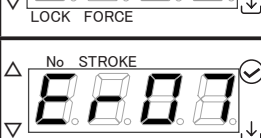
Also, do not store the product while it is inserted in the unit or charger.

## ● List of error indication

Error indication	Error content	Cancellation method
 <p>No STROKE LOCK FORCE &lt;Display blinks&gt;</p>	<p>The rivet nut was not loaded correctly into the machine. The rivet nut is not touching the tip of the nosepiece and is not secured in place.</p>	<p>Set the forward/reverse switch to reverse, pull the trigger switch to reverse the screw mandrel, and remove the rivet nut from the screw mandrel. After removing the rivet nut, return the forward/reverse switch to forward. (See Page26)</p>
 <p>No STROKE LOCK FORCE &lt;Display blinks&gt;</p>	<p>Screw mandrel initial position error. The screw mandrel is not in the initial position.</p>	<p>Set the forward/reverse switch to reverse and pull the trigger switch. The screw mandrel will move to the initial position. After that, return the forward/reverse switch to forward. (See Page 26)</p>
 <p>No STROKE LOCK FORCE &lt;Display blinks&gt;</p>	<p>Stroke setting error</p>	<p>Press and hold the Select button for at least 5 seconds. The machine will return to a working state.</p>
 <p>No STROKE LOCK FORCE &lt;Display blinks&gt;</p>	<p>Force output setting error</p>	<p>Press and hold the Select button for at least 5 seconds. The machine will return to a working state.</p>
 <p>No STROKE LOCK FORCE &lt;Display blinks&gt;</p>	<p>Overcurrent error. An excessive current flowed inside the unit.</p>	<p>Press and hold the Select button for at least 5 seconds. If the error appears again, leave the device in a cool place for a while.</p>
 <p>No STROKE LOCK FORCE &lt;Display blinks&gt;</p>	<p>Motor high temperature error. The motor temperature is higher than normal.</p>	<p>Press and hold the Select button for at least 5 seconds. If the error appears again, leave the device in a cool place for a while.</p>
 <p>No STROKE LOCK FORCE &lt;Display blinks&gt;</p>	<p>Motor control circuit high temperature error. The temperature of the motor control circuit is higher than normal.</p>	<p>Press and hold the Select button for at least 5 seconds. If the error appears again, leave the device in a cool place for a while.</p>
 <p>No STROKE LOCK FORCE &lt;Display blinks&gt;</p>	<p>Battery pack high temperature error. The battery pack temperature is higher than normal.</p>	<p>Press and hold the Select button for more than 5 seconds. If the error appears again, wait for the battery pack to cool down or replace it.</p>
 <p>No STROKE LOCK FORCE &lt;Display blinks&gt;</p>	<p>Battery pack low temperature error. The battery pack temperature is lower than normal.</p>	<p>Press and hold the Select button for more than 5 seconds. If the error appears again, leave the device in a warm place for a while or replace the battery pack.</p>
 <p>No STROKE LOCK FORCE &lt;Display blinks&gt;</p>	<p>Battery pack high voltage error. The voltage supplied from the battery pack has become higher than normal for some reason.</p>	<p>Press and hold the Select button for more than 5 seconds. If the error appears again, replace the battery pack.</p>
<p>No STROKE LOCK FORCE &lt;Display blinks&gt;</p>	<p>Battery pack low voltage error. The voltage supplied from the battery pack has become lower than normal for some reason.</p>	<p>Press and hold the Select button for more than 5 seconds. If the error appears again, replace the battery pack.</p>

Output value setting table for our rivet nuts

Thread Size		M3	M4				M5			
Our product number		3M	4M	415M	425M	435M	5M	515M	525M	535M
Product number (NTK)		3M15	4M	4M20	4M25	4M35	5M	-	5M30	-
NSK	Force No.	05	30	20	15	20	40	45	45	35
NSD	Force No.	-	40	15	15	15	70	40	45	50
NAK	Force No.	-	10	10	10	05	20	15	15	15
NAD	Force No.	-	10	10	05	05	20	20	15	15
NTK	Force No.	30	40	40	35	40	55	-	55	-
NSK-MR	Force No.	-	30	-	-	-	45	-	-	-
NSD-MR	Force No.	-	15	-	-	-	50	-	-	-

Thread Size		M6			M8			M10		
Our product number		6M	625M	640M	8M	825M	840M	10M	1025M	1040M
Product number (NTK)		6M	-	6M40	8M	-	8M40	10M	-	10M40
NSK	Force No.	60	55	65	65	80	85	80	85	95
NSD	Force No.	65	60	60	85	85	85	-	85	85
NAK	Force No.	40	45	45	70	50	55	-	55	55
NAD	Force No.	45	45	50	55	50	65	-	55	50
NTK	Force No.	55	-	70	65	-	99	65	-	95
NSK-MR	Force No.	60	-	-	95	-	-	99	-	-
NSD-MR	Force No.	70	-	-	95	-	-	-	-	-

\* When using the NSK-6M rivet nut, the setting is "60" .

\* "-" in the table indicates that it is not included in our standard rivet nut lineup.

## ● Serial No.

\* The serial number of the cordless rivet nut setter is displayed on the bottom of the unit as three letters (date of manufacture) and a five-digit number.

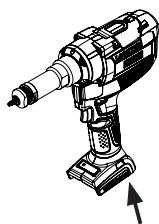

Bottom of main body

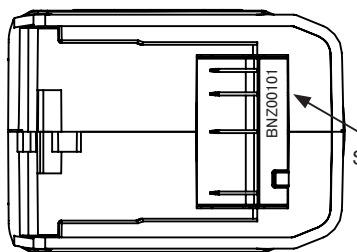

Serial number location

How to view the manufacturing year/month

Manufacturing year/month	1	2	3	4	5	6	7	8	9	10	11	12
Code	A	B	M	N	K	W	T	Y	U	O	L	Z

Examples) 2 0 ② ④ Year ⑫ Month



Serial number

↓ ↓      ↓  
 B N      Z      ⇒ BNZ ○○○○○

# ● Troubleshooting



Please check the items below before assuming that the product is broken. If you have checked all of them and the problem still persists, please contact us or request repairs. When making inquiries or requesting repairs, please check the items below and provide as much detail as possible about the usage conditions, symptoms, etc. This will help shorten the time it takes to complete repairs.

\* In the table, screw mandrel is referred to as mandrel.

Symptoms	Cause	Corrective action
<p>The screw chuck does not rotate even when the rivet nut is pressed. The leftmost part of the monitor screen is 「E」</p> 	<p>The forward/reverse switch is in reverse.</p>	<p>Set the forward/reverse switch to forward rotation. (See page 26)</p>
<p>The mandrel does not rotate even when the rivet nut is pressed against it. An error message appears on the monitor.</p> 	<p>The rivet nut has already been taken in. (The mandrel is not in the initial position.)</p>	<p>For safety reasons and to prevent damage to the machine, it is not possible to perform continuous feeding operations. Please reverse the operation to return the mandrel to its initial position. (See page 26)</p>
<p>The mandrel does not rotate even when the rivet nut is pressed against it. No error message displayed on the monitor.</p>	<p>The battery is empty.</p>	<p>Please charge the battery.</p>
	<p>The machine is not turned on.</p>	<p>Press the trigger switch to turn on the power.</p>
	<p>After using a hex wrench to forcibly turn the mandrel to remove a stuck rivet nut, you forget to turn it three times clockwise.</p>	<p>When removing the rivet nuts, remove the battery pack, insert the included hexagonal wrench into the rear of the unit, and rotate the mandrel counterclockwise. Then rotate it clockwise three times. (See page 27)</p>
<p>The mandrel rotates forward but does not pick up the rivet nut.</p>	<p>The mandrel size is not the correct size for the rivet nut.</p>	<p>Replace the mandrel with one that fits the size.</p>
	<p>There is dirt on the mandrel threads.</p>	<p>Remove any debris from the mandrel.</p>
	<p>Mandrel threads are worn or damaged.</p>	<p>Replace with a new mandrel.</p>
	<p>The threads on the rivet nut are damaged.</p>	<p>Use a different rivet nut.</p>
<p><b>The rivet nut does not tighten even when the trigger switch is pulled.</b></p>	<p>The rivet nuts are not properly inserted. The following error is displayed on the monitor.</p> 	<p>Turn the forward/reverse switch to reverse to remove the rivet nut from the mandrel, then turn it back to forward and reinsert it (see page 26).</p>
		<p>Check the mandrel threads for wear or damage.</p>
		<p>Check the mandrel projection.</p>

## ● Troubleshooting

ENGLISH

Symptoms	Cause	Corrective action
The rivet nut does not tighten even when the trigger switch is pulled.	The forward/reverse switch is in the middle position. 	Please put the forward/reverse switch in the forward position. 
	The stroke is too short to tighten the rivet nut.	Please review the stroke settings. (See page 19)
	The output is too small to tighten the rivet nut.	Please review the output settings. (See page 19)
After crimping, the rivet nut cannot be removed from the mandrel.	The mandrel protrudes too far.	Please check the mandrel protrusion. When removing the rivet nuts, remove the battery pack, insert the included hex wrench into the rear of the unit, and rotate the mandrel counterclockwise. Then rotate it clockwise three times. (See pages 18 and 27)
After crimping, the rivet nut bites into the mandrel and does not come off.	The rivet nut is over-tightened, damaging the threads of the rivet nut.	The stroke or output may be excessive. Please review the settings. When removing the ebini, remove the battery pack, insert the included hex wrench into the rear of the unit and rotate the mandrel counterclockwise. Then rotate it clockwise three times. (See pages 19 and 27)
The mandrel is damaged or broken.	Mandrel life.	Replace with a new mandrel.
	The same rivet nut was tightened twice.	Do not tighten the rivet nuts twice.
	The rivet nuts were tightened with the aircraft tilted.	Use the unit so that it is perpendicular to the base material.
The rivet nut spins freely after being tightened.	The rivet nut is not tight enough.	The stroke is too short or the output is too low. Please review the settings. (See page 19)
The power does not turn on even when the trigger switch is pulled.	The battery pack is empty.	Charge the battery pack (see page 14).
	There is dirt or dust on the contact points between the battery pack and the main unit.	Remove any debris that may be stuck to it.
	The battery pack protection function has been activated due to an overload.	Remove the cause of the overload.
The work light does not turn on.	The light is set to off.	Press the work light ON/OFF switch. (See page 24)
The number of nuts that can be tightened when fully charged has been significantly reduced.	The battery pack may have reached the end of its life.	Please replace with a new battery pack.
The battery pack will not charge even when it is plugged into the charger.	The power cable is not connected.	Connect the power cable correctly (see page 14).
	here is dirt on the contacts between the charger and the battery pack.	Remove any dirt that may be adhering to the product (see page 28).
It takes a long time to complete charging.	The battery pack is hotter than normal. (Orange flashing; waiting to charge)	Wait until the battery pack cools down before charging.
	The battery pack is cooler than normal.	Leave the battery pack in a location between 10°C and 35°C for about an hour before charging.



## ● How to order parts

Please specify the model name, part name, code number and quantity as shown below and place your order with the store where you purchased it.

Model name	Part name	Code No.	quantity
N1B1	Nosepiece M3	71773	1pièces
N1B1	M3 Screw mandrel	71779	1pièces

\* Please note, if parts are upgraded, the old product will be in stock for 5 years.

## ● Cordless rivet nut setter N1B1 Parts list

No.	Part name	Code No.	Expendable parts	Material
1	Nosepiece M3	71773	○	steel
2	Nosepiece M4	71774	○	steel
3	Nosepiece M5	71775	○	steel
4	Nosepiece M6 *	71776	○	steel
5	Nosepiece M8	71777	○	steel
6	Nosepiece M10	71778	○	steel
7	Screw mandrel M3	71779	○	steel
8	Screw mandrel M4	71780	○	steel
9	Screw mandrel M5	71781	○	steel
10	Screw mandrel M6 *	71782	○	steel
11	Screw mandrel M8	71783	○	steel
12	Screw mandrel M10	71784	○	steel
13	Lock nut *	71785	-	steel
14	plate spanner	71817	-	steel
15	Hexagonal rod wrench	71818	-	steel
16	Battery pack BPL-1825	-	○	①

- Parts marked with \* are assembled at the time of shipment.
- Parts marked with an ○ mark on the consumables item are those that require periodic replacement.
- The material ① is a lithium-ion battery. Recycle the product in accordance with laws and regulations.

### Optional accessories

17	Large capacity battery pack BPL-1850	-	○	①
----	--------------------------------------	---	---	---

### Charger

18	Charger BC037T(for 120V)	-	○	Electronic device
	Charger BC037T(for 230V)	-		
19	Power cable (for 120V)	68759	○	②
	Power cable (for 230V)	68760		

- A power cable is included with the BC037T.
- Material ② contains copper, plastic and rubber.

# ● Cordless rivet nut setter N1B1 Parts diagram

ENGLISH

